

proNivo ■■■



PN | Catalog

2018
2019

Distribution for construction, surveying and locating

pronivo.de

	<i>Page</i>
PNHLR/G Pendulum Rotary Laser	3
PNRLR-1B Rotary Laser	4
PNRLR-1D Rotary Laser	5
PNRLR-2D Rotary Laser	6
PNRLR/G-3D Rotary Laser	7
PNGLR Grade Laser	8
PNLUD18 Universal Laser Detector	9
PNRLD-MM Millimeter Laser Detector	10
RD200 Laser Detector	11
PNLLX Cross Line Laser	12
PNLL360 Line Laser 360°	13
PNTL45 Tile Laser	14
PNHCMG Pendulum Line Laser	15
PNCMG-2D Multi Line Laser	16
PNCMG-3D Multi Line Laser	17
PNML-H4V4 Multi Line Laser	18
Laser Accessories	19-20
PNAL Optical Levels	21
PNSL Optical Levels	22
DGTA Theodolites	23
SmartTrak 101/102 Magnetic Locators	24
MagnaTrak 100/102 Magnetic Locators	25

	<i>Page</i>
Contractor's Heavy-Duty Tripods	26
Elevator Aluminum Tripods	27
Surveyor-Construction Tripods Wood/ Fiberglas	28
Other Tripods, Rods and Accessories	29
Rods and Accessories	30
Measuring Wheels	31
Prisms & Accessories 0/-30 mm	32
Multiple Prisms	33
Prisms & Accessories -34,4 mm	34
Special Prisms	35
Mini Prism Sets	36
Prism Sets	37
Carbon Poles	38-39
Aluminum Poles	40
Accessories	41
Prism Poles	42
Bipods, Tripods and Accessories	43
Adapters, Tribrachs, Nails	44
Order form	45
General information	46

proNIVO Messgeräte Handels GmbH

**Wasserburger Straße 7
84427 Sankt Wolfgang
Germany**

**Tel: +49 (0) 8085 - 930 530
Fax: +49 (0) 8085 - 930 550**

**E-Mail: info@pronivo.de
Web: www.pronivo.de**

PN | Rotary Laser

PNHLR/G | Horizontal Rotary Laser, pendulum leveling (SKU no. 205-PNHLR and 205-PNHLG)

Features

- Choose between red or green beam pendulum laser
- Very stable in temperature variations
- **Use the high rotary speed of 2000 rpm to see the rotary beam like a steady line**
- Best visibility thanks to the green beam, even at highest rotary speed!
- Inexpensive and reliable rotary laser
- Ideal for jobs with frequent re-positioning of the laser



Technical Data

Leveling accuracy	$\pm 3 \text{ mm}/30 \text{ m}$
Leveling range	$\pm 4^\circ$
Working range	Up to 400 m (red)/250 m (green) radius with detector
Laser Class	2 (red: 635 nm, green: 520 nm)
Power supply	Lithium-Ion battery (20 h)
Operating temperature	-10°C to $+45^\circ\text{C}$
IP protection	IP55
Rotary speed	800, 450, 2000 rpm
Dimensions	215 mm (length) x 150 mm (width) x 156 mm (height)
Weight	2.0 kg

**PENDULUM COMPENSATED
FOR QUICKEST LEVELING**

Application

For all types of simple interior and exterior leveling jobs, e.g. laying composition floors, depth control for excavators, foundations, walls, height control, landscaping

Scope of delivery

- Rotary Laser PNHLR (red) or PNHLG (green)
- Rechargeable Lithium-Ion battery and charger
- Target
- Laser glasses
- Transportation case
- Instruction manual

Optionally we can provide the universal detector PNLUD18 or the digital millimeter read-out detector PNRLD-MM.



Use our high-quality universal detector PNLUD18 (page 9) to cover a large working range of up to 800 m (red diode) in diameter! Thanks to the latest technology this detector receives rotary and line laser beams! For even more benefits you can use our digital millimeter read-out detector (page 10), red beam only.

We offer suitable tripods, rods and other accessories. Contact us for more information!



PN | Rotary Laser

PNRLR-1B | Horizontal Rotary Laser, one-button operation (SKU no. 205-PNRLR-1B)

Features

- Very easy one-button operation
- Ideal for all leveling jobs
- With height alert
- Usage with laser detector
- Accessories in the case

Technical data

Leveling accuracy	$\pm 2.3 \text{ mm}/30 \text{ m}$
Rotary beam	Horizontal
Leveling range	$\pm 4^\circ$
Working range	Up to 400 m radius with detector
Laser class	2 (635 nm)
Power supply	Lithium-Ion battery (29 h)
Operating temperature	-10 to +45°C
IP protection	IP55
Rotary speed	800, 450, 2000 rpm
Dimension	215 mm (length) x 150 mm (width) x 156 mm (height)
Weight	1.9 kg



VERY EASY ONE-BUTTON OPERATION

Application

For all types of leveling jobs in construction and landscaping, fundaments, height control, height transfer,...

Scope of delivery

- Rotary Laser PNRLR-1B
- Rechargeable Lithium-Ion battery and charger
- Target
- Laser glasses
- Transportation case
- Instruction manual

Optionally we can provide the universal detector PNLUD18 or the digital millimeter read-out detector PNRLD-MM.

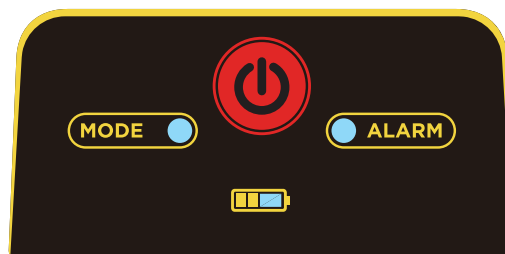

Very easy operation with one button only

Use our high-quality universal detector PNLUD18 (page 9) to cover a large working range of up to 800 m in diameter! Thanks to the latest technology this detector receives rotary and line laser beams! For even more benefits you can use our digital millimeter read-out detector (page 10).

We offer suitable tripods, rods and other accessories. Contact us for more information!



PN | Rotary Laser

PNRLR-1D | Horizontal Rotary Laser, manual slope function (SKU no. 205-PNRLR-1D)

Features

- High precision due to electronic leveling
- Manual slope function in one axis
- Highest rotation speed of 2000 rpm. The rotating beam is like a precise line on a surface, e.g. a wall.
- All functions and slope can be set with the remote control
- Scanning function and height alert



Technical Data

Leveling accuracy	$\pm 2.3 \text{ mm}/30 \text{ m}$
Rotary beam	Horizontal
Leveling range	$\pm 4^\circ$
Slope capability in one axis	-4° to $+4^\circ$
Working range	Up to 400 m radius with detector
Laser class	2 (635 nm)
Power supply	Lithium-Ion battery (29 h)
Operating temperature	-10°C to $+45^\circ\text{C}$
IP protection	IP55
Rotary speed	800, 450, 2000 rpm
Dimensions	215 mm (length) x 150 mm (width) x 156 mm (height)
Weight	1.9 kg

ELECTRONIC LEVELING FOR HIGHEST ACCURACY

Application

For all types of construction work, e.g. depth control for excavators, foundations, walls, height control, landscaping, and all kinds of leveling

Scope of delivery

- Rotary Laser PNRLR-1D
- Rechargeable Lithium-Ion battery and charger
- Target
- Laser glasses
- Remote control
- Transportation case
- Instruction manual

Optionally we can provide the universal detector PNLUD18 or the digital millimeter read-out detector PNRLD-MM.

Use our high-quality universal detector PNLUD18 (page 9) to cover a large working range of up to 800 m in diameter! Thanks to the latest technology this detector receives rotary and line laser beams! For even more benefits you can use our digital millimeter read-out detector (page 10).

We offer suitable tripods, rods and other accessories. Contact us if you have questions. We surely have the right product for your customers.



PN | Rotary Laser

PNRLR-2D | | Horizontal & Vertical Rotary Laser, manual slope function (SKU no. 205-PNRLR-2D)

Features

- Highest precision due to electronic leveling
- Horizontal and vertical rotary beam
- Manual slope function in one axis
- Highest rotation speed of 2000 rpm. The rotating beams are like thin lines on a surface, e.g. a wall.
- All functions and the slope can be set via the remote control
- Scanning function and height alert



Technical Data

Leveling accuracy	$\pm 2.3 \text{ mm}/30 \text{ m}$
Rotary beam	Horizontal and vertical
Leveling range	$\pm 4^\circ$
Slope capability in one axis	-4° to $+4^\circ$
Working range	Up to 400 m radius with detector
Laser class	2 (635 nm)
Power supply	Lithium-Ion battery (16-25 h)
Operating temperature	-10°C to $+45^\circ\text{C}$
IP protection	IP55
Rotary speed	800, 450, 2000 rpm
Dimensions	215 mm (length) x 150 mm (width) x 156 mm (height)
Weight	2.0 kg

**NO RE-POSITIONING
OF THE UNIT FOR
VERTICAL ALIGNMENT**

Application

For all construction work, also for indoor use, e.g. placing drywalls, pending ceilings, alignment of columns, fundamentals and walls, height control, leveling tasks, alignment of axes on the jobsite etc.

Speciality

This laser has a horizontal and a vertical laser beam. It is not necessary to re-position the laser for vertical alignment applications! You can work with the horizontal and vertical reference at the same time. Choose the highest rotation speed of 2000 rpm! The rotating beam appears like a precise line on the wall, however is much more accurate than a line laser.

Scope of delivery

- Rotary Laser PNRLR-2D
- Rechargeable Lithium-Ion battery and charger
- Target
- Laser glasses
- Transportation case
- Instruction manual

Optionally we can provide the universal detector PNLUD18 or the digital millimeter read-out detector PNRLD-MM.

Use our high-quality universal detector PNLUD18 (page 9) to cover a large working range of up to 800 m in diameter! Thanks to the latest technology this detector receives rotary and line laser beams! For even more benefits you can use our digital millimeter read-out detector (page 10).

Ask us for suitable tripods, rods and other accessories!



PN | Rotary Laser

PNRLR/G-3D | Horizontal & Vertical Rotary Laser, manual slope function (SKU no. 205-PNRLR/G-3D)

Features

- Unique and innovative rotary laser with three rotation heads – 3 dimensions in one instrument!
- Choose between red and green laser beam
- Highest precision due to electronic leveling
- Horizontal and two vertical beams in 90° angle
- Manual slope function in one axis
- All functions and the slope can be set with the remote control
- Highest rotation speed of 2000 rpm. The rotating beams are like three precise lines on a surface, e.g. a wall.
- Cross points up and down
- Scanning function and height alert



Technical Data

Leveling accuracy	± 2.3 mm/30 m
Rotary beam	Horizontal and 2x vertical
Leveling range	± 4°
Slope capability in one axis	-4° to +4°
Working range	Up to 400 m (red)/250 m (green) radius with detector
Laser class	2 (red: 635 nm, green: 520 nm)
Power supply	Lithium-Ion battery (7-29 h)
Operating temperature	-10°C to +45°C
IP protection	IP55
Rotary speed	800, 450, 2000 rpm
Dimensions	215 mm (length) x 150 mm (width) x 156 mm (height)
Weight	2.1 kg

3 AXES IN ONE UNIT
UNIQUE AND INNOVATIVE

Application

Due to the horizontal and two vertical beams the PNRLR-3D is ideal for all construction tasks, but also for interior applications (especially the green beam version). The setup of profile boards, placing drywalls, 90° angle transfer, pending ceilings, alignment of columns, fundamentals and walls are only a small part of applications with this innovative laser. Further usage possibilities: height control, alignment of axes on the jobsite, leveling tasks, landscaping.

Speciality

Recommend the green beam 3D laser especially to customers who are doing interior construction and finishing! They benefit from a higher accuracy than with line lasers. Due to the high rotary speed of the PNRLG-3D the three green rotary beam appear like precise and steady lines on the wall! With the two vertical beams you can use all references, laser crosses, the plumb point and the horizontal leveling beam. No re-positioning of the laser, no re-alignment, no additional rotary lasers! One instrument for all axes! Use our optional alignment base for aligning the vertical beams around the plumb point!

Scope of delivery

- Rotary laser PNRLR-3D (red) or PNRLG-3D (green)
- Rechargeable Lithium-Ion battery with charger
- Target
- Laser glasses
- Remote control
- Transportation case
- Instruction manual

Optionally we can provide the universal detector PNLUD18 or the digital millimeter read-out detector PNRLD-MM.

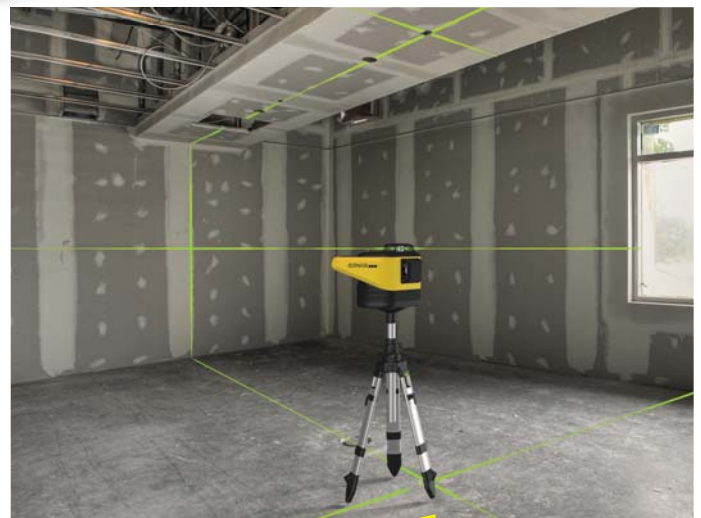

GREEN BEAM -
BEST VISIBILITY



PN | Rotary Laser

PNGLR | 1D and 2D Dial-In Grade Laser, radio remote, digital slope control (SKU no. 213-PNGLR-1D and 2D)

Features

- Dual dial-in grade ($\pm 7\%$) in both axes
- Can be sloped horizontally and vertically at the same time
- Operation via buttons or radio remote control
- Alignment of vertical beams with the PNGLR-2D (hor./vert.)
- Different rotary speeds with up to 2000 rpm
- Smart H.I. Alert System alerts user when laser has been disturbed or drifts (ADS)

Technical Data

Leveling accuracy	$\pm 2.3 \text{ mm}/30 \text{ m}$
Rotary beams	Horizontal and vertical
Leveling range	$\pm 4^\circ$
Slope capability	$\pm 7\%$ (in both axes)
Working range	Up to 400 m radius with detector
Laser class	2 (635 nm)
Power supply	Lithium-Ion battery (25 h)
Operating temperature	-10°C to $+45^\circ\text{C}$
IP protection	IP55
Rotary speed	1000, 400, 2000 rpm
Dimension	215 mm (length) x 150 mm (width) x 156 mm (height)
Weight	2.0 kg

Application

For all construction work, e.g. sloped areas, garage paths, placing drywalls, pending ceilings, alignment of columns, fundamentals and walls, height control, alignment of axes on the jobsite, leveling tasks, landscaping, setup of profile boards, angle transfer

Scope of delivery

- Rotary Laser PNGLR-1D or PNGLR-2D
- Rechargeable Lithium-Ion battery and charger
- Target
- Laser glasses
- Transportation case
- Instruction manual

Optionally we can provide the universal detector PNLUD18 or the digital millimeter read-out detector PNRLD-MM.

Use our high-quality universal detector PNLUD18 (page 9) to cover a large working range of up to 800 m in diameter! Thanks to the latest technology this detector receives rotary and line laser beams! For even more benefits you can use our digital millimeter read-out detector (page 10).

We offer suitable tripods, rods and accessories. Contact us for more information!

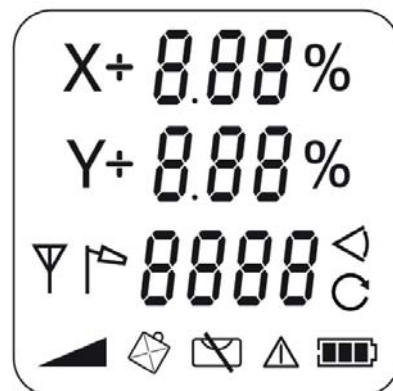

PN | Universal Laser Detector

PNLUD18 | Universal Detector for Rotary and Line Lasers (SKU no. 304-PNLUD18)

Features

- Further development of the universal laser detector for almost all rotary and line lasers
- Compact and easy-to-use instrument with 60 mm reception window
- Strong, widely visible LEDs and interval signals for height indication
- Three accuracy levels
- Filter against flash light and sun light
- Display with 5 channels, front and back side
- Mode and detection frequency are stored
- Magnets for fixing on steel profiles
- Very stable clamp with screw fixing
- Power supply with one AA battery only

Technical data

Detection height	60 mm
Detection angle	$\pm 45^\circ$
Wave length	450 to 800 nm
Accuracy (mm)	
Fine	0.3
Medium	1
Coarse	3
Volume	Normal/loud/off
Working range rotary laser	Up to 400 m
Working range line laser	Up to 75 m
Rotary laser detection	300-1200 rpm
Line laser detection	7 to 12 kHz
Automatic switch-off	After 30 minutes
Power supply	1x 1.5 V AA battery
Operating time	For about 50 h
Operating temperature	-10°C to +50°C
IP protection	IP67



RED - GREEN
ROTARY - LINE

Clamp

The rod clamp of the PNLUD18 is extremely robust. It can be quickly attached to the rod, saves time and can be fixed on different materials and shapes.

Application

Detection of red and green beams of rotary and line lasers and measurement of the height difference.

Scope of delivery

- Universal detector PNLUD18
- Clamp
- 1 AA battery



We offer survey rods and other accessories for detectors! We are happy to help you!

PN | Universal Laser Detector

PNRLD-MM | | Detector with digital mm readout (SKU no. 304-PNRLD-MM)

Features

- Digital readout of the laser height in millimeters
- Huge 90 mm reception height
- Offset in the reception can be set individually
- Extreme robustness for the toughest construction jobs
- Very small, compact and easy to use
- Strobe light rejection filter built-in
- High resolution photo diode with anti-reflection technology

Technical data

Detection range	1 m - 300 m (depending on rotary laser)
Reception window height	90 mm
Reception angle	± 70°
Channels	9
Accuracy (mm)	
Fine	1,0
Medium	2,0
Coarse	5,0
Very coarse	10,0
Laser wave length	450 nm to 800 nm
Power supply	1 x 1.5 V AA battery
Operating time	50+ hours
Dimensions (without clamp)	134 x 69 x 25 mm
Weight (without clamp)	175 g
Operating temperature	-20°C to +50°C
IP protection	IP67

RED - GREEN
ROTARY - MILLIMETER



Speciality - programmable offset

Using the programmable offset you can set the zero line as you need it: between -10 and +45 mm of the reception window. If the laser levels which you want to detect are normally higher than the laser detector, shift the zero line accordingly. You will see the reading earlier to precisely align your zero elevation. A big advantage for your customers!

Clamp

The rod clamp of the PNRLD-MM is extremely robust. It can be quickly attached to the rod, saves time and can be fixed on different materials and shapes.

Application

Detection of rotating beams and a precise millimeter readout of the elevation difference

Scope of delivery

- Millimeter readout detector PNRLD-MM
- Clamp
- 1 AA battery



We offer survey rods and accessories for detectors!

PN | Rotary Laser Detector

RD200 | Rotary Laser Detector (SKU no. 213-RD200 and 213-RD200-G)

Features

- Two accuracy settings for rough and final grade checking
- Robust rod clamp
- Built-in leveling bubble vial for precise alignment
- Well-arranged keypad
- Button for sensitivity and volume
- Front and back LCD displays for ease of use in the field
- Rugged housing and sealed for water and dust protection
- Saves the direction in which the laser light left the reception window
- Available for red and green rotary laser beams

Technical data

Detection height	46 mm
Accuracy (mm)	
Fine	1.5
Coarse	2.5
Volume	Normal/loud/off
Power supply	9V Alkaline battery
Operating time	More than 20 h
Operating temperature	-20°C to +50°C
IP protection	IP44

Clamp

Thanks to the universal mount fixing the clamp on round, oval or angular rods or profiles is no problem.

Application

Detection of rotating lasers and measurement of the height difference

Lieferumfang

- Rotary laser detector RD200 (red) or RD200-G (green)
- Clamp
- 9V battery



We offer rods and accessories for detectors. Contact us!

Have a look on our universal detector PNLUD18 (page 9) which detects rotary as well as line lasers. **A real innovation for your customers!** We also offer our PNRLD-MM digital readout detector for rotary lasers which gives you a precise millimeter reading!

PN | Cross Line Laser

PNLLX | Cross Line Laser for interior use - red/green (SKU no. 218-PNLLX)

Features

- Self-leveling cross line laser
- Choose between red and green beam
- Precise laser cross to the front, with manual slope possible
- Large laser output window
- Clear and precise laser lines
- Operation with one button only
- With 1/4" thread for fixing on mounts or tripods
- Very small, compact and light
- With transportation lock to avoid damage
- With protection bag and universal bracket



Technical data

Leveling accuracy	$\pm 3 \text{ mm}/9 \text{ m}$
Working range	Up to 10 m, depending on the light conditions
Laser class	2 (red: 635 nm, green: 520 nm)
Power supply	3x 1.5 V AAA batteries
Operating time	More than 15 h
Compensator	Magnetically dampened
Leveling range	$\pm 3^\circ$
Leveling speed	Ca. 3 s
Out-of-level sensor	Yes, with warning tone
Special feature	Manual mode for extreme slopes
Weight	180 g with mount
Universal adapter	1/4" x 20 thread

Application

Interior leveling and plumbing work, e.g. electric installations, furniture, installation work, tiling and flooring, painting, pending ceilings, alignment of axes, building in drywalls, kitchens, light bars, interior decoration etc.

Scope of delivery

- Cross line laser PNLLX
- Universal bracket
- 3 AAA batteries
- Protective bag
- Instruction manual



We offer tripods, clamps and other accessories for line lasers. Contact us!



Interior application

PN | 360°-Line Laser

PNLL360 | Line Laser 360° with two verticals and detector function (SKU no. 218-PNLL360)

Features

- Self-leveling multi line laser
- Horizontal 360° leveling beam, two vertical plumb beams in a 90° angle, two laser crosses and lines with manual slope
- Full 360° horizontal line
- Two verticals in 90° angle, also with laser crosses
- Clear and precise laser lines
- Compact and lightweight instrument, easy to transport
- Selection of laser lines with one button only
- With transportation lock to avoid damage
- Usage of line laser detector outside or in bright light
- 1/4" thread for fixing on mounts and tripods

Technical data

Accuracy	$\pm 3 \text{ mm}/10 \text{ m}$
Working range	Up to 20 m. 50 m with detector, depending on the light conditions
Laser class	2M (635 nm)
Power supply	3 x 1.5 V AA batteries
Operating time	Minimum 12 hours if all laser lines are activated
Leveling range	$\pm 3^\circ$
Leveling speed	< 3 seconds
Out-of-level sensor	Yes, with warning tone
Special feature	Manual mode for extreme slopes
Weight	320 g with mount
Universal adapter	1/4" x 20 thread

Application

Interior leveling and plumbing work, e.g. electric installations, furniture, installation work, tiling and flooring, painting, pending ceilings, alignment of axes, building in drywalls, kitchens, light bars, interior decoration etc., 90° angle transfer and check.

Scope of delivery

- Cross line laser PNLL360
- Magnetic mount
- Target
- 3 AA batteries
- Instruction manual
- Transportation bag

Optional: Universal detector PNLUD18



optional: universal detector PNLUD18



Two vertical beams



PN | Tile Laser

PNTL45 | Tile laser with 45° line (SKU no. 205-PNTL45)

Features

- Compact and easy to use
- Continuous laser lines (work without further tools)
- Two spirit levels
- Two adjustment feet for leveling on uneven surfaces
- 5 mm distance to the floor. It is possible to put tiles under the unit
- Detector mode
- Ideal for every tiler

Technical data

Leveling accuracy	± 1.0 mm / 1 m
Angular accuracy	± 2.5 mm / 10 m
Working range	10 m. Up to 40 m with detector
Laser class	2M (635 nm)
Laser lines	5
Power supply	3x 1.5 V AA batteries
Operating time	ca. 10 h
Operating temperature	-10°C to +45°C
IP protection class	IP55 except battery housing

One button operation

- 1x: 2 laser lines in 90° angle
- 2x: 3 laser lines in 45° angle
- 3x: 5 laser lines, additional line backwards
- 4x: All laser lines off
- With all laser lines on, pressing the button for approx. 4 seconds activates the detector mode

Application

Projection of laser lines in 45° and 90° angles on walls and floor for tiling

Scope of delivery

- Tile laser PNTL45
- 3 AA batteries
- Target
- Protective bag
- Instruction manual and quick start manual

Optional: Universal detector PNLUD18

Your customers can use this tile laser with our new universal detector PNLUD18 (page 9). One detector only for rotary and line lasers! This is real innovation.

We also offer suitable accessories for your customers. Contact us!



optional: universal detector PNLUD18

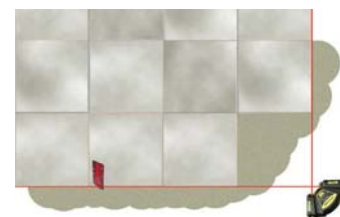

90° line

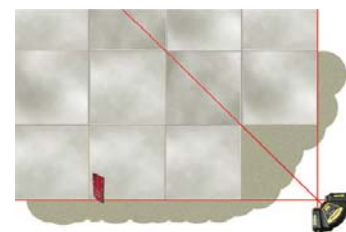

45° and 90° lines

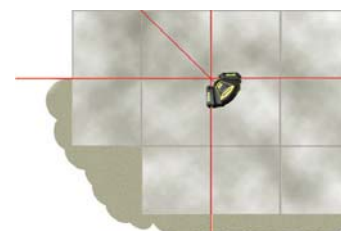

All laser lines

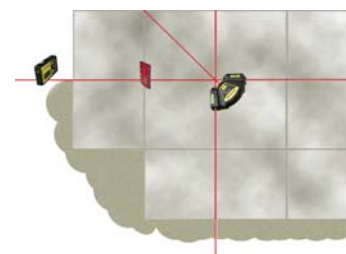

All laser lines with detector

PN | Line Laser

PNHCMG | Horizontal Line Laser, pendulum leveling (SKU no. 205-PNHCMG)

Features

- Best visibility due to the bright, green laser beam
- Very rugged against temperature variations
- Release the pendulum lock for switching the laser on
- Inexpensive and reliable rotary laser
- Innovative technique with cone mirror: projection of a 360° laser line with only one diode
- Ideal for a lot of interior jobs and leveling work outside
- Can be used with a detector



**BEST LASER DIODE
FOR BEST VISIBILITY**

Technical data

Leveling accuracy	± 1.5 mm/10 m
Leveling type	Pendulum compensated
Leveling range	± 4°
Working range	> 80 m in radius with detector
Laser class	2M (green: 520 nm)
Power supply	Lithium Ion battery (28 h)
Operating temperature	-10°C to +45°C
IP protection	IP55
Laser output angle	360°
Dimensions	215 mm (length) x 150 mm (width) x 156 mm (height)
Weight	2,0 kg

Application

For all interior leveling work, and simple exterior application. Kitchen, shelves, cupboards, stairs, lamps, pending ceilings, drywalls, doors and much more. Ideal also for laying composition floors.

Scope of delivery

- Multi line laser PNHCMR/G
- Rechargeable Lithium-Ion battery with charger
- Target
- Laser glasses
- Transportation case
- Instruction manual

Optional: Universal detector PNLUD18



Ask us for suitable accessories! We offer tripods, rods, clamps, vials and much more to offer a complete portfolio to you and your customers.

PN | Multi Line Laser

PNCMG-2D | Multi line laser with green diodes (SKU no. 205-PNCMG-2D)

Features

- The innovative splitting and mirroring of a laser beam to a line makes it possible to offer a very high operating time and excellent precision standards
- Highly visible, green beams: 360° horizontal and vertical
- Indoor and outdoor application with detector
- Precise and electronic leveling for highest accuracy
- Ideal for all interior finishing applications
- Cross point of both laser lines



**GREEN BEAM
FOR BEST VISIBILITY**

Technical data

Leveling accuracy	± 1.0 mm / 10 m
Leveling type	Electronic
Self leveling range	± 4°
Working range	> 150 m with detector, depending on light
Laser class	2M (green: 520 nm)
Power supply	Lithium-Ion battery (15-24 h)
IP protection	IP55
Dimensions	215 mm (length) x 150 mm (width) x 156 mm (height)
Weight	2.0 kg

Operation with buttons

- Horizontal button for horizontal 360° leveling line
- Vertical button for the vertical 360° line

Application

For all leveling and plumbing tasks indoor and also for small outdoor jobs. Usage for kitchens, shelves, cupboards, stairs, lamps etc. pending ceilings, setting up dry walls and doors.

Speciality

Use the horizontal and vertical line simultaneously as reference for transferring elevations angles and for aligning axes. The laser does not need to be re-positioned as both lines can be projected at the same time!

Scope of delivery

- Multi line laser PNCMG-2D
- Rechargeable Lithium-Ion battery with charger
- Target
- Laser glasses
- Transportation case
- Instruction manual

Optional: Universal detector PNLUD18



We also offer high quality accessories for your customers. Contact us!

PN | Multi Line Laser

PNCMG-3D | Multi line laser with green diodes (SKU no. 205-PNCMG-3D)

Features

- No re-positioning of the laser to use vertical references
- Cross point of all three laser lines
- Innovative technique of splitting and mirroring a laser beam to a line, therefore very high operating time and excellent precision standards
- One horizontal and two vertical 360° lines in 90° angle
- Indoor and outdoor application with detector
- Precise and electronic leveling
- Highly visible, green beams
- Ideal for all interior finishing applications



**NO RE-POSITIONING OF THE LASER
TWO VERTICALS IN 90°**

Technical data

Leveling accuracy
Self leveling range
Working range

$\pm 1.0 \text{ mm} / 10 \text{ m}$
 $\pm 4^\circ$ (electronic)
> 150 m with detector,
depending on light

Laser class

2M (green: 520 nm)

Power supply

Lithium-Ion battery (8-24 h)

IP protection

IP55

Dimensions

215 mm (length) x
150 mm (width) x
156 mm (height)

Weight

2.0 kg

Operation with buttons

- Horizontal button for horizontal 360° leveling line
- V1 Vertical button for the first vertical 360° line
- V2 Vertical buttons for the second vertical 360° line

Application

For all leveling and plumbing tasks indoor and also for small outdoor jobs. Usage for kitchens, shelves, cupboards, stairs, lamps etc. pending ceilings, setting up dry walls and doors.

Speciality

The two 360° vertical lines offer real advantages for your customers, especially for interior construction! Both lines project a 90° angle and create several intersections with the horizontal leveling line. Especially for drywall applications and interior finishing you can use both vertical lines for aligning axes, transferring angles and for checking the verticality of walls, door and other objects. A real projective boost for your customers!

Scope of delivery

- Multi line laser PNCMG-3D
- Rechargeable Lithium-Ion battery with charger
- Target
- Laser glasses
- Transportation case
- Instruction manual

Optional: Universal detector PNLUD18

We also offer suitable accessories for your customers. Contact us!



PN | Multi Line Laser

PNML-H4V4 | Multi line laser (SKU no. 205-PNML-H4V4)

Features

- Horizontal 360° line and four vertical lines which are in a 90° angle towards each other
- The lines are visible on the floor, the walls and the ceilings.
- Separately switchable lines
- Self-leveling with pendulum
- Outdoor use with detector possible
- Down plumb point
- Robust against to vibrations and temperature changes
- Ideal for all leveling and plumbing tasks indoor

Technical data

Leveling accuracy	± 2.0 mm / 10 m
Orthogonal accuracy	± 30 seconds
Plumb point accuracy	± 4.0 mm / 10 m
Self-leveling range	± 3.5°
Working range	20 m. Up to 60 m with detector
Laser class	2M (635 and 650 nm)
Laser lines	5
Power supply	4x 1.2V NiMH rechargeable batteries or C batteries
Operating time	10-40 h, depending on activated laser lines
Leveling time	6 seconds maximum



Operation with buttons

- Horizontal: 180°, 360°, off
- Vertical: 2 verticals, 4 verticals, off
- Any combination of horizontal and vertical lines is possible
- Detector mode
- Manual mode for slopes

Application

For all interior leveling and plumbing work and small tasks outdoor, 90° angle transfer, especially drywall applications, electric installations, furniture, installation work, tiling and flooring, painting, pending ceilings, alignment of axes, kitchens, light bars, interior decoration,...

Scope of delivery

- PNML-H4V4 Multi line laser
- 4 NiMH rechargeable batteries with charger
- Target
- Laser glasses
- Transportation bag
- Instruction manual and quick start manual

Optional: Universal detector PNLUD18

We offer accessories for this laser. Tripods, detectors, clamps etc. Offer added value to your customers!

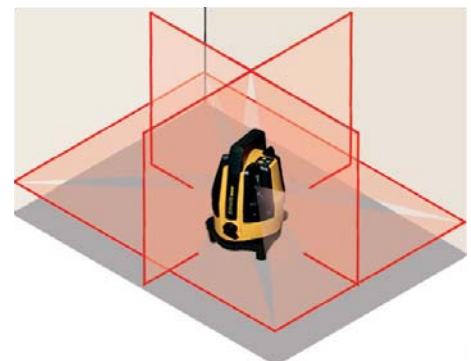
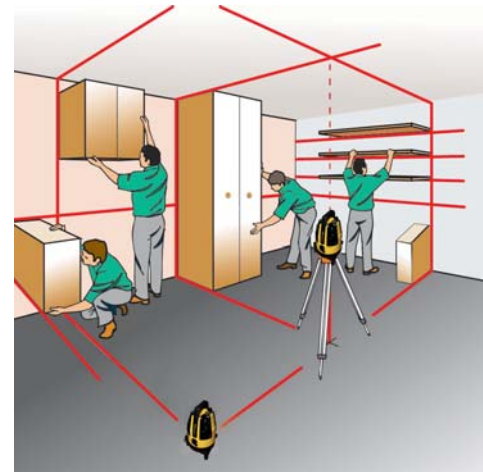

PN | Laser Accessories

205-WALLMOUNT

Universal mount WALLMOUNT

- Height adjustable universal mount
- Mounting of laser on walls and ceiling for interior construction
- Stable fixation of your instrument with the 5/8" stud
- Push button for quick and comfortable height adjustment
- Spring against the wall
- Hole for mounting on marks (e.g. screw or nail)
- Suitable for all line and point lasers, also for light rotary lasers



218-PNBBC

Profile Board Mount

- Heavy duty mount with 5/8" thread
- Mounts all theodolites and construction lasers
- Removable plate with clamp
- Length: 175 mm, maximum diameter: 55 mm
- Clamp with three M10 screws



205-PNTB90

Rotary Laser Grade Adapter PNTB90

- Setting your laser on the desired grade
- Usage of horizontal lasers in manual mode like dial-in grade lasers with slope in one axis
- Grade indication on 180° circle
- Integrated vial with ± 10 seconds accuracy
- With 5/8" mounting stud
- Big and stable knob
- Robust spring to maintain the grade
- Suitable for all rotary lasers



205-PNRB

Rotation Base

- Stable rotation base made of stainless steel
- With turning knob for aligning the vertical laser beam
- Accurate fine adjustment knob for highest precision
- Precise alignment of the beam towards one reference, e.g. construction axes, doors, windows, drywalls
- Mount with 5/8" thread on a tripod

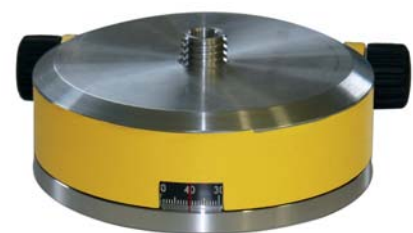

PN | Laser Accessories

205-PNMAB

Alignment Base for 3D lasers

- Use all benefits of your 3D laser!
- Alignment of the laser around the intersection point of both vertical lines
- The intersection point of both vertical lines is always on the same position
- Alignment of the lines on axes and references
- Fine adjustment drive of the vertical beams
- Mount with 5/8" thread on a tripod

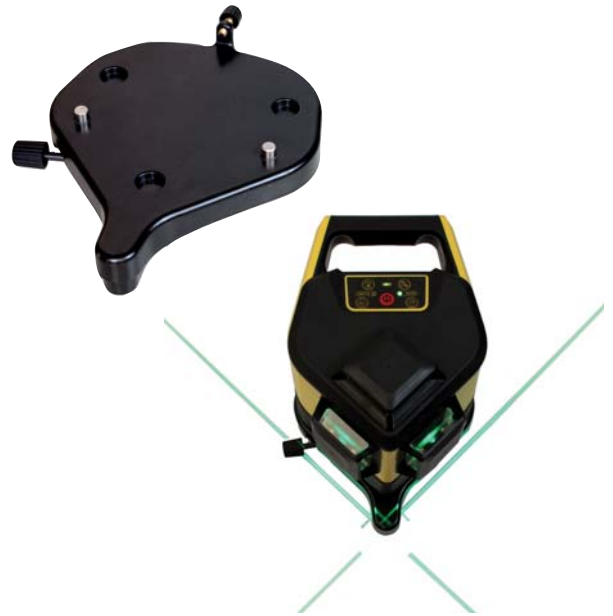

205-PNRRC

Radio remote control for PNRL Rotary Laser Series

- All functions of the rotary lasers (except PNRLR-1B) can be set via the radio remote control
- Laser line slope via buttons or radio remote control
- Long range
- Identical symbols like on the rotary laser keypad



Additional accessories for PN-L Rotary and Line Lasers

For the rotary and line lasers of the PN-L series and for a lot of other laser models with red and green diode we offer accessories as additional equipment or for replacement.

SKU no.	Description
205-PNCHARGER	Charger for all Rotary and Line Lasers of the PN-L laser series
205-LA13163-0-12C	Rechargeable Lithium-Ion battery for all Rotary and Line Lasers of the PN-L laser series
205-GLASSES	Laser glasses for better visibility of red laser beams
205-GLASSES-G	Laser glasses for better visibility of green laser beams
205-TARGET	Laser target for better visibility of red laser beams
205-TARGET-G	Laser target for better visibility of green laser beams



PN | Optical levels

PNAL | Optical levels (SKU no. 205-PNAL-24 and 205-PNAL-32)

Features

- Sturdy metal housing with rubber reinforcement
- Water and dust protected
- Fast aperture
- Magnetically dampened compensator
- Circular vial with penta prism
- Fine motion knobs on both sides with friction-braked rotation, endless horizontal drive
- Large focusing knob
- Target collimator
- Transportation case with double lock and accessories
- 2 years of warranty



Technical data

Magnification	24x	32x
Accuracy at 1 km double leveling	2 mm	1 mm
Objective aperture	36 mm	40 mm
Field of view	1° 20'	1° 20'
Minimum focus range	0.3 m	0.3 m
Graduated circle	1°/1 gon	1°/1 gon
Thread	5/8"	5/8"
Weight without case	1.8 kg	1.8 kg

Application

For building patios, houses and baseplates, for landscaping, excavation height control, survey work on the jobsite and in the field

Scope of delivery

- Optical level
- Transportation case
- Protective cap
- Plumb
- Cord
- Adjustment tool
- Allen wrench key
- Instruction manual

Service

Our technicians calibrate, service and repair your optical levels. We offer a base and full service according to the customer's wish. Contact us for more information!



Offer your customers a leveling set with tripod and rod. Ask for your best set price!

PN | Optical levels

PNSL | Optical levels (SKU no. 205-PNSL-24 and 205-PNSL-32)

Features

- Models with 24x and 32x magnification
- Light and compact
- Superior optics
- Magnetically dampened compensator
- Endless horizontal drive
- High precision level

Technical data

Magnification	24x	32x
Leveling accuracy 1.6 mm	at 45 m	at 75 m
Working range	90 m	120 m
Objective aperture	32 mm	36 mm
Field of view	1° 25'	1° 25'
Minimum focus	0.3 m	0.3 m
Horizontal circle	1°/1 gon	1°/1 gon
Thread	5/8"	5/8"
Weight without case	1.7 kg	1.7 kg



WITH OUTSTANDING OPTICS

Application

For all precision leveling tasks on jobsites, building patios, houses and baseplates, for landscaping etc.

Scope of delivery

- Optical level
- Transportation case
- Plumb
- Cord
- Adjustment tool
- Allen wrench key
- Instruction manual

Service

Our technicians calibrate, service and repair your optical levels. We offer a base and full service according to the customer's wish. Contact us for more information!



Offer your customers a leveling set with tripod and rod. Ask for your best set price!

PN | Theodolites

DGTA | Digital Theodolite (SKU no. 205-DGTA-5 and 205-DGTA-2)

Features

- 5 and 2-seconds digital theodolites
- Simple and precise angular measurement
- Large, dual-sided display
- Vertical axis compensator for highest accuracy (DGTA-2 only)
- Accessories
- Absolute Encoding: it is not necessary to turn the objective around 360° after switching on. The instrument shows immediately the vertical angle!

Technical data

Telescope

Objective length	155 mm
Objective aperture	45 mm
Objective magnification	30x
Image	Erect
Field of view	1°30'
Minimum focus range	1.3 m

Electronic angular measurement

Method	Incremental
Minimum reading	5"/10" (DGTA-5), 5"/1" (DGTA-2)
Accuracy	5"/1.5 mgon (DGTA-5), 2"/0.5 mgon (DGTA-2)
Diameter	82 mm
Lightning	Display and ocular

Optical plumb

Magnification	3x
Field of view	5°
Focus	0.5 to infinity

Miscellaneous

Power supply	Rechargeable NiMH batteries
Foot	Detachable
Operating temperature	-20°C to +50°C
Dimensions	20 (L) x 15 (W) x 30 (H) cm
Weight	4.4 kg without case

Application

Ideal for all angle measurements on the jobsite

Scope of delivery

- Digital theodolite
- Sunshade and solar filter
- Tool kit and plumb bob
- Rain cover and drying cloth
- Rechargeable NiMH batteries
- Transportation case
- Instruction manual



With optical plummet
3x magnification



Large, dual display -
easy to read



SmartTrak | Magnetic Locators

ST101 and ST102 | Magnetic locator (SKU no. 201-ST101 and 201-ST102)

Features

- Modern membrane push buttons for controlling the sensitivity and the volume
- Lightweight, ergonomic and balanced design allows single hand usage
- Tough, lightweight aluminum tube with durable rubber tip
- Indication of electric fields when moving over a power cable
- Numeric and acoustical indication of the magnetic field strength
- The ERASE function makes it possible to get good location results near metal fences or other big metal objects (ST102 only)
- Special SMART+ mode for detecting vertical objects (ST102 only)
- The complete pole is waterproof

Technical data

Power supply	6x 1.5 V AA batteries
Operating time	Ca. 100 h normal usage
Sensitivity	6 settings
Loudspeaker	Waterproof, high performance loudspeaker with plastic cover
LC display	Numeric and bar indication from 0 to 99, indication for low battery and power cable detection
Operating temperature	-20°C to +60°C
Length	109 cm
Weight	1.1 kg with batteries
Housing	Very rugged and water-proof

Application

- Location of ferromagnetic objects in the ground, below water, black top and snow
- Location of locking rods and manhole covers
- Location of iron survey pipes
- Location of points which have been marked magnetically

Scope of delivery

- Magnetic locator ST100 or ST102 (with ERASE function)
- 6 AA batteries
- Protective bag
- Instruction manual

Service

Prior to deliver to you or your customer the units are calibrated to the magnetic field. Therefore we have a test field with marked geographic directions.

SmartTRAK



NEW DEVELOPMENT
WITH SMART MODE



CST/berger | Magnetic Locators

MagnaTrak100 Series | Magnetic locator (Art.Nr. 004-19-200SC)

Features

- Large and clear LC display
- The numeric value and the bar graph allow a visual estimation of the relative force of the magnetic field
- Display of electric fields when moving over an electricity cable
- Turning knobs (MT100)
- ERASE function (MT102 only): fading out disturbing magnetic fields without the need to reduce the sensitivity
- The complete pole is waterproof

Technical data

Power supply	6x 1.5 V AA batteries
Operating time	Ca. 100 h normal usage
Loudspeaker	High performance loudspeaker with rugged plastic cover
LC display	Numeric digital value from 0 to 99, indication for low battery and power cable detection
Operating temperature	-20°C to +50°C
Length	ca. 105 cm
Weight	1.3-2 kg with batteries
Housing	Very rugged and water-proof plastic
Made in	USA

Application

- Location of ferromagnetic objects in the ground, below water, black top and snow
- Location of locking rods and manhole covers
- Location of iron survey pipes
- Location of points which have been marked magnetically

Scope of delivery

- Magnetic locator MT100 and 102
- 6 AA batteries
- Protective bag
- Instruction manual

Service

Prior to deliver to you or your customer the units are calibrated to the magnetic field. Therefore we have a test field with marked geographic directions.



Contractor's Tripods | Aluminum with Quick Clamp

Our contractor's tripods are equipped with an ergonomic excenter and quick clamp, very stable and robust and feature an excellent price-performance-relation. They are ideal for the daily use on the job site. Mount your instrument easily with the 5/8" thread. Convenient transport with its carrying straps. All tripods are made of resistant aluminum components and therefore protected in severe weather conditions. The clamps can be used easily, even with gloves. Choose between dome and flat head. For optical levels, some users prefer the dome head for an easy horizontation of the instrument.

SKU number	Details	Size	Weight	Color
201-60-ALQCI20	<ul style="list-style-type: none"> • Quick clamp • Flat head 	extend.: 160 cm collap.: 97 cm	3.7 kg	orange, black
201-60-ALQCI40	<ul style="list-style-type: none"> • Quick clamp • Dome head 	extend.: 160 cm collap.: 97 cm	4.1 kg	orange, black



201-60-ALQCI20

Heavy-Duty Tripods | Aluminum with Wing Screw

The extra stability due to double banded, extendable legs shows the difference to other aluminum tripods.

SKU number	Details	Size	Weight	Color
201-60-ALW20	<ul style="list-style-type: none"> • Wing screw • Big round head 	extend.: 165 cm collap.: 107 cm	5.5 kg	black, orange
201-60-ALWI20	<ul style="list-style-type: none"> • Wing screw • Flat head 	extend.: 165 cm collap.: 107 cm	5.5 kg	black, orange



201-60-ALWI20

Heavy-Duty Tripods | Aluminum with Quick Clamp

The heavy-duty tripods ALQRI20 and ALQR20 feature all benefits of the above mentioned leveling tripods, but offer superior stability. The very robust tripod legs are made of high quality and thick aluminum and provide best stand even on challenging environment and with heavy instruments. That is why we recommend these tripods for usage with rotary lasers. The user will benefit from better safety and more comfort in his daily work. The hinges and tips of the tripods are made of metal. All parts are replaceable.

SKU number	Details	Size	Weight	Color
201-60-ALQRI20	<ul style="list-style-type: none"> • Quick clamp • Flat head • Very stable and robust 	extend.: 165 cm collap.: 107 cm	5.5 kg	black, orange
201-60-ALQR20	<ul style="list-style-type: none"> • Quick clamp • Big dome head 	extend.: 165 cm collap.: 107 cm	5.5 kg	black, orange



201-60-ALQRI20

Your advantage: Our tripods stand out due to especially strong and stable aluminum profiles! Compare our proNIVO tripods with similar equipment in this price range. You will be astonished!

Telescope and Elevator Tripods | For Construction made of Aluminum

Our elevator tripods are made of robust aluminum profiles with thick walls. The quality aluminum tube as middle column can be moved up or down without efforts. The metal gear and rack system provide a smooth and continuous motion. The elevation crank is self-impeding and prevents the column to move down. The hinges and tips are made of metal. All parts are replaceable. With carrying straps and 5/8" thread.

We offer elevator tripods in different lengths. All versions feature the proven quick clamp with its thick, ergonomic metal lever. The aluminum parts are weather resistant and anodized. The plastic parts are fiber-reinforced to ensure usage in severe weather conditions.

A speciality of our elevator tripods ALQRI-ELAZ are the tips with height adjustable rubber caps. For interior usage loosen the screws (downwards). The tripod stands directly on the caps and does not damage the floor (e.g. wooden parquet floor). Additionally, the rubber facilitates the set-up of the tripod on slippery floors and keeps it stable on its position. For exterior usage, tighten the screws (upwards). The aluminum tips can be pressed into the ground to get optimal stability.

SKU number	Details	Size	Weight	Color
201-60-ALELT20	<ul style="list-style-type: none"> • Quick clamp • Telescope column 	extend.: 183 cm collap.: 105 cm	5.4 kg	black
201-60-ALQRI10ELAZ	<ul style="list-style-type: none"> • Quick clamp • Perfect for 1 m reference • Gear system 368 mm height 	extend.: 139 cm collap.: 84 cm	5.9 kg	black
201-60-ALQRI15ELAZ	<ul style="list-style-type: none"> • Quick clamp • Extendable up to 2.20 m • Gear system and elevation column 	extend.: 220 cm collap.: 84 cm	6.2 kg	black
201-60-ALQRI20ELAZ	<ul style="list-style-type: none"> • Quick clamp • Extendable up to 2.95 m • Rack system and elevation column 	extend.: 295 cm collap.: 122 cm	7.2 kg	black

**WITH TELESCOPE COLUMN -
EASY HEIGHT ADJUSTMENT**



201-60-ALELT20
With telescope column



201-60-ALQRI20ELAZ
Elevator tripod
with telescope column

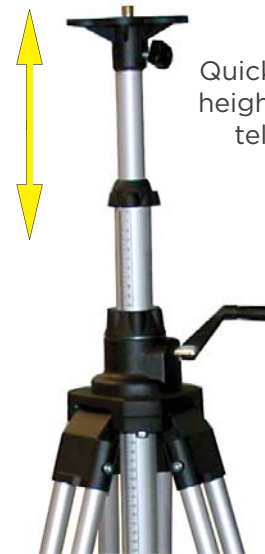

Quick and comfortable height adjustment with telescope column

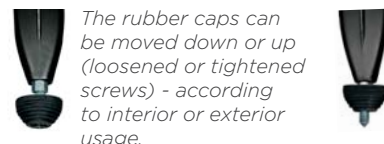

The rubber caps can be moved down or up (loosened or tightened screws) - according to interior or exterior usage.

Heavy-Duty Tripods | Wood/Fiberglas

Ideal for theodolites and (robotic) total stations, heavy rotary lasers and laser scanners. These tripods are made of modern and table fiberglas and have two main advantages in comparison to traditional wood or aluminum tripods:

- The extension coefficient of fiberglas is very low. In heat or cold, aluminum can stretch or contract and therefore influences the measurement. Fiberglas is non-sensitive, even in big temperature variations.
- In regular usage it often happens that the varnish of wood tripods is broken. Humidity intrudes into the wood, the wood starts to swell and can damage the tripod. Fiberglas is non-sensitive towards humidity and therefore features a higher durability and longer life cycle.

For heavy instruments we recommend the tripods WDF19MAX and WDF20MAX:

- The quick clamp guarantees a quick set-up and high clamp stability, even for heavy instruments.
- The wing screw offers additional safety for motorized total stations with high torsional moment.

SKU number	Details	Size	Weight	Color
201-60-WDF20MAXD	<ul style="list-style-type: none"> • Quick clamp and wing screw, especially stable! • Completely made of fiberglas • Round head plate Ø 168 mm 	extend.: 183 cm collap.: 107 cm	7.9 kg	yellow
201-60-WDF19MAXD	<ul style="list-style-type: none"> • Quick clamp and wing screw, especially stable! • Completely made of fiberglas • Standard triangle head plate 	extend.: 183 cm collap.: 107 cm	7.8 kg	yellow
201-60-WDW20HV	<ul style="list-style-type: none"> • Wing Screw • Made of wood 	extend.: 183 cm collap.: 107 cm	5.5 kg	yellow



Round tripod head (WDF20MAXD)



Triangle tripod head (WDF19MAXD)



201-60-WDW20HV



201-60-WDF20MAXD



Quick clamp

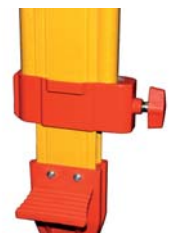

Wing screw

218-TFG

Tripod Floor Guide with rubber loops, 2 positions, 470 g

- Ideal when setting up a tripod on slick surfaces and concrete floors. Makes setting up over a point faster!
- Made of high quality Aluminum
- The rubber loops provide an excellent fixation of the tripod
- Avoid instruments falling down
- Legs extend to 64 cm, can be collapsed, 2 different stand positions for the tripod



218-TFG

Tripods | Machine Control

Very high stability for your heavy instruments like laser scanners, big rotary lasers, monitoring stations etc., but also for higher construction applications than standard tripods can give you.

SKU number	Details	Size	Weight	Color
201-60-MCT	Machine Control Tripod Elevator column up to 43 cm	extend.: 4.22 m collap.: 1.84 m	13 kg	silver
201-60-MCTE	Machine Control Tripod Elevator column up to 43 cm	extend.: 5.16 m collap.: 2.1 m	15.4 kg	silver



201-60-MCT

Other Tripods and Accessories

SKU number	Details	Size	Color
201-60-BAG20ELAZ	Tripod bag, Cordura	Length: 122 cm, Diameter: 22 cm	orange
218-PNTA	Tripod adapter	5/8 to 1/4x20	silver



201-60-BAG20ELAZ



218-PNTA

Rods | Telescoping Leveling Rods made of Aluminum

Metric scale, light and stable aluminum alloy. Robust and resistant polycarbonate buttons for locking the individual sections. Leveling scale on the front side, cm measuring scale on the back. Smooth extension due to tight tolerances on the sections. All sections are protected with weather and corrosion resistant paint. As additional option we offer a transportation and protection bag (201-06-820).

SKU number	Details	Length
201-06-805M-RG	<ul style="list-style-type: none"> • 5 Sections • Graduation in cm and mm • Reverse mm scale from the bottom to the top on the back side 	5 m
201-06-804MME 201-06-805MME	<ul style="list-style-type: none"> • 4 or 5 sections • Graduation in cm and mm • Measuring of clear heights and headrooms (distance floor - ceiling) on the back side • Reverse mm scale from the bottom to the top on the front side • Normal mm graduation on the back side • Triple scale 	4 m or 5 m



201-06-805M-RG
reverse scale from
bottom to the top
on the back side



201-06-805MME
front mm scale

Telescoping Leveling Rods made of Fiberglas

Ideal for use in water. Corrosion resistant and non-conductive fiberglas. Leveling scale on the front side, measuring scale on the back. Smooth extension due to tight tolerances on the sections. All sections are protected with weather and corrosion resistant paint.

SKU number	Details	Length
201-06-904M	4 Sections, with bag	4 m
201-06-905M	5 Sections, with bag	5 m
201-06-907M	6 Sections, with bag	7.6 m



201-06-904M
201-06-905M and
201-06-907M equal

Cut-and-Fill Rod

Metric scale, height adjustable and stable aluminum rod with integrated vial. Scale with zero point in the middle (front side). Quick Lock™ mechanism. Color-coded rod (red means too high, white means too low). Foot with spring for easy extension. With bracket for mounting a receiver. Usage with lasers.

Application

- Transferring and measuring of height and height differences
- Ideal for alignments and adjustment of ceilings

SKU number	Details	Length
201-06-TLMB	2 Sections	2.4 m
201-06-TLMB-LV	2 Sections	3.6 m

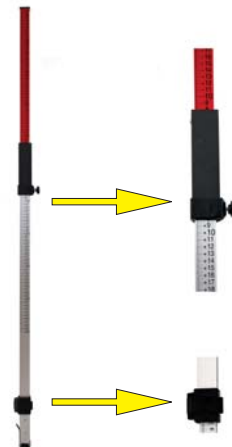

201-06-TLMB

Accessories for Rods

SKU number	Details
201-06-750	Attachable and adjustable vial
201-06-850	Clip-on vial for aluminum rods
201-06-950	Clip-on vial for fiberglas rods
201-06-820	Nylon bag, suitable for all telescope rods made of aluminum



201-06-820



201-06-850



201-06-950

Miscellaneous

SKU number	Details
201-04-501	Marking needles red/white (11 pc/box)
201-04-511	Ring for marking needles



201-04-501



201-04-511

PN | Measuring Wheels

Rolatape was founded in the USA in 1950 and is one of the worldwide leading brands for all kinds of measuring wheels. Rolatape specializes in providing quality distance measuring wheels - for both commercial and residential measuring applications. Rolatape has the right wheel for your needs - small wheels for simple indoor measuring to large diameter wheels that handle the roughest outdoor terrain.

Rolatape Measuring Wheels

- Brand ROLATAPE
- Wheel diameter 31.83 cm
- Wheel circumference 1 m
- Grained wheel circumference
- Guaranteed precision of 0,05%
- Large magnified counter up to 10,000 m
- Smallest unit 1 cm
- With stand to keep the wheel upright when not in use
- Wheel brake for more accurate measuring
- Folding handle with restraint for compact storage and transport
- Durable and built to last steel construction

201-32-416M

ROLATAPE Measuring Wheel

The full wheel is a solid and very stable aluminum cast wheel for usage in the field. If you have to measure distances in high grass, meadows or in the wood, grass or branches remain in the spokes of a spoke wheel and block the precise measurement. The full wheel is suitable for any surface.

Weight: 3.4 kg

201-32-401M

ROLATAPE Spoke Wheel

The spoke wheel is lighter than a disk wheel and hence easier to transport and to use. The most popular application of the spoke wheel is distance measurement on pavement, dirt and rough surfaces and in urbanized areas. Ideal for road construction, landscaping, janitorial, general construction, appraisals, accident reconstruction and crime scenes.

Weight: 3.2 kg

201-31-312M

Spoke Wheel

- Made of stable, but light aluminum
- Handle made of high quality plastic
- Wheel circumference 1 m
- Counter up to 10,000 m
- Smallest unit 1 dm
- Folding handle for compact storage and transport
- With stand to keep the wheel upright when not in use
- Weight: 1.4 kg



201-32-416M



201-32-401M



201-31-312M

PN | Prisms & Accessories 0/-30

206-6310-00

Prism with metal holder and target

- Offset 0 and -30 mm
- Tilt axis height 100 mm
- Precision 5 seconds
- 62,5 mm prism
- Orange target for high visibility
- Stainless steel tension adjusting knob
- Bayonet adapter with interior 5/8" thread



206-6310-00

201-63-2010M

Prism with metal holder and quality plastic target

- Offset 0 and -30 mm
- Tilt axis height 115 mm with bayonet adapter
- Precision 2"
- 62 mm prism
- Orange/white target
- Holder made of metal, target made of high quality polycarbonate
- With notch for targeting
- Fully compatible with leading manufacturers like Sokkia, Trimble, Topcon etc.
- 360° tilt capable



201-63-2010M

206-6320-11-O and 206-6320-11-B

Prism

Available in orange and black, suitable for all holders with M20 thread (standard thread for prisms)

- Diameter 62 mm
- Precision 5 seconds



206-6320-11-O



206-6320-11-B

206-6330-11-B

Prism

Single prism in black, suitable for all holders with M20 thread (standard thread for prisms)

- Diameter 62 mm
- Precision 5 seconds
- Copper-coated to avoid fogging



206-6330-11-B

PN | Multiple Prisms

218-CRZ122

360° Prism, Leica compatible

- Compatible with Leica 360° prisms
- Compatible with the Leica SmartAntenna
- Copper-coated
- Range up to 600 m
- With 5/8" thread on the top for mounting a GNSS receiver



218-CRZ122

218-CTP1

360° Prism, Sokkia/Topcon compatible

- Compatible with Sokkia and Topcon 360° prisms
- Compatible with Sokkia and Topcon robotic stations
- Silver-coated
- Offset -7 mm
- Six precision-machined cubes mounted in solid metal core housing
- < 5 sec. accuracy
- With additional inner 5/8" thread (top) for mounting a center punch point or GNSS receiver



218-CTP1

218-6336-00

360° Prism for robotic total stations

- Precision 360° prism for quick and accurate measurements with robotic total stations
- The structure of the single prisms makes it possible to find and track the prism quickly.
- Seven 25.4 mm prisms
- Offset 0 mm
- With height adapter and 5/8" thread



218-6336-00

218-6513-60

360° Mini prism

- Offset -30 mm
- Compatible with Leica instruments
- Highest quality standard during the production process
- Ideal for 360° survey applications
- Push button for easy removing from the pole
- Scope of delivery includes a four-section pole and bag
- Holder with vial



218-6513-60

PN | Prisms & Accessories

206-6335-23

Prism (Type GPH1)

- Offset -34 mm, central symmetric
- Precision 5 seconds, copper-coated
- Leica push button
- With holder and target made of stable metal
- With brass insert for mounting on a prism pole
- Central symmetric point (visible prism center) is in the axis of the prism holder



206-6335-23

206-6335-22

Prism with holder, type GPH1

- Offset -34 mm, central symmetric
- Tilt axis height 86 mm, copper-coated
- Precision 5 seconds
- Leica push button system with brass insert



206-6335-22

206-6335-25

Holder for single prism, type GPH1

- Offset -34 mm
- Tilt axis height 86 mm
- Compatible with prism type GPH1
- Made of high quality plastic
- Leica push button with brass insert



206-6335-25

206-6335-24

Copper-coated prism

- Single prism, type GPR1 - Leica compatible
- Precision 5 seconds
- Copper-coated prism prevents fogging in wet and cold climate



206-6335-25

206-6335-26

Target for GPH1 compatible prism

- Made of stable metal
- Luminous yellow or red for best visibility



206-6335-26

206-6335-12

Holder for GPH1A compatible single prism

- Made of high quality plastic
- Luminous yellow for best visibility
- Leica push button with brass insert



206-6335-12

PN | Special Prisms

206-6430-10 and 206-6430-20 Prism in L shape, standard and mini

The 25.4 mm prism in L shape is very robust and ideal for your survey work in mines or for jobsite monitoring. It is mainly used in locations where a prism is permanently mounted.

- Very robust
- Glass body (precision 5") integrated in housing
- Holder and housing made of stable aluminum
- Copper-coated prism to prevent fogging
- Can be mounted on wall bolts/dowels with an M8 screw



206-6430-10

206-6430-20

206-4000-CH and 218-4100-CH (white and yellow) Mounting reflector - low price opportunity

This reflector is ideal for working on distances up to 200 m and is also used for measurements in tunneling or for long time monitoring. The disadvantage of normal reflective targets is eliminated with our reflector. The marker can be turned to align it in an optimum way towards the total station.

- The positioning and centering of the reflector can be done very precisely. The center hole supports the high accuracy.
- Light and robust against weather and sunshine
- Neither the holder nor the reflective foil „swell“
- Very resistant against the hard conditions on the jobsite (e.g. sprayed concrete, vibrations, extreme temperatures)
- Offset 2 mm
- Bracket made of stable and high quality plastic
- With Leica style connection

Optional accessories:

- Installation adapter (218-4112-14) for gluing or screwing (yellow only)
- Adapter Leica to 3/8" thread for convergence bolt (white/yellow)
- Adapter Leica to 5/8" thread (218-4112-15) for any application (white/yellow)



206-4000-CH

218-4100-CH
and 218-4112-13

206-4012-10 and 218-4112-10 (white and yellow) Mini prisms - low price alternative

A mini prism is integrated in this reflector which allows measurements of longer distances up to 600 m. The prisms are light and robust. They are especially used for monitoring applications, rail track survey and other automated survey jobs.

- With weather protection for the prism glass
- Special glass which is resistant against atmospheric conditions
- Offset -17,5 mm
- Tilt axis height 86 mm
- 25,4 mm mini prism
- Ideal for permanent observation and tunnel construction
- Bracket made of stable and high quality plastic
- With Leica style connection

Optional accessories:

- Installation adapter (218-4112-14) for gluing or screwing (yellow only)
- Adapter Leica to 3/8" thread for convergence bolt (white/yellow)
- Adapter Leica to 5/8" thread (218-4112-15) for any application (white/yellow)



206-4012-10

218-4112-10
and 218-4112-13



218-4112-13

218-4112-14

206-6450-00 Prism for floor monitoring

Usage and fixation on the floor, on roads or hardly accessible areas. Size ca. 10 x 10 x 2,5 cm.

- Very stable aluminum protection
- 17 mm prism for floor monitoring
- Fixation with dowels, grout and glue
- Consider the position of the total station when you fix the prism to be able to target the glass.

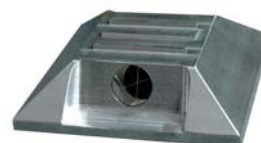

206-6450-00



PN | Mini Prism Sets

206-6535-00

Mini prism stakeout set (Leica type)

- Offset -17 mm
- Tilt axis height 86 mm / with tip 120 mm
- Diameter 25.4 mm (1 second)
- Precision 5 seconds, copper-coated
- Target and holder made of metal
- Leica push button system
- Center vial, with plumb tip and protective bag



206-6535-00



206-6515M-00-O

Mini prism with center vial

- Offset 0 or -30 mm
- Tilt axis height 70 and 100 mm (5/8" thread)
- Diameter 25.4 mm, precision 5 seconds
- Round target made of metal
- On-board centered circular vial, U form bracket
- With stakeout tip, plumb tip and protective bag



206-6515M-00-O



206-6515S-00-O

Mini prism with side vial

- Offset 0 oder -30 mm
- Tilt axis height 70 and 100 mm (5/8" thread)
- Diameter 25.4 mm, precision 5 seconds
- Round target made of metal
- On-board circular bubble leveling vial, U form bracket
- With stakeout tip, plumb tip and protective bag



206-6515S-00-O



206-6525S-00

Mini prism with side vial

- Offset 0 or -30 mm
- Tilt axis height 70 and 100 mm (5/8" thread)
- Diameter 25.4 mm, precision 5 seconds
- Silver-coated prism
- Large target and holder made of metal
- Side vial for easy read-out, U form bracket
- With stakeout tip, plumb tip and protective bag



206-6525S-00

206-6515-12

Mini prism Standard 1" (25.4 mm)

206-6515-12SC

Mini prism, silver-coated to prevent fogging

206-6535-12

Mini prism, copper-coated to prevent fogging



206-6515-12

PN | Prism Sets

206-6518-00

Mini prism stakeout set

- Stakeout set with adjustable mini prism
- Offset 0 mm
- Height adjustable holder with mini prism (25.4 mm)
- Precision 5 seconds
- Aluminum prism pole with four sections, 30 cm each
- Total pole length 1.30 m
- With vial
- With carrying bag for poles and prism



206-6518-00

218-6515-20-OC

Mini prism for stakeout

- Offset 0 or -30 mm
- Precision 5 seconds
- Diameter 25.4 mm
- Copper-coated
- Adjustable vials on the top and the bottom
- With fixed heights for mounting on the prism pole
- With stake out tip and bag



218-6515-20-OC

206-6517-RL

Stakeout set with reflective target and metal frame

- Offset 2 mm
- Stakeout height 100 mm, maximum 130 mm
- Metal prism pole with four sections, 30 cm each
- Integrated reflective target with crosshairs on one side
- Stable metal frame around the reflective target
- Size of the reflective target 60x60 mm
- Range up to 150 m
- With bag



206-6517-RL

206-6440-00

Mini prism with protective cap

- Stable frame with aluminum mounting base
- Removable, very robust protective cap
- Protection against rain, fog and dew
- Can be permanently fixed with screws
- Can be aligned upwards and downwards



206-6440-00

PN | Carbon Fiber Poles

206-CP18V and 206-CP18V-L

Carbon fiber pole for GNSS receiver with fixed height

- Two section pole made of lightweight and stable carbon-fiber
- Fixed height at 1.80 m
- Especially short and equally long segments for small vehicles!
- The especially stable middle part prevents the carbon material to break if a pole bracket for a heavy tablets is attached very firmly
- With 5/8" adapter (206-CP18V) or Leica style connector (206-CP18V-L) for standard GPS height
- Weight 0.75 with carrying bag

**SHORT SEGMENTS -
PERFECT FOR SMALL VEHICLES**



206-CP20V and 206-CP20V-L

Carbon fiber pole for GNSS receiver with fixed height

- Strengthened middle part for tablet brackets
- Two section pole made of lightweight and stable carbon-fiber
- Fixed height at 2 m
- With two optional openings in the upper segment for cables
- With 5/8" adapter (206-CP20V) or Leica system (206-CP20V-L) for standard GPS height
- Ideal for usage with GNSS receivers
- Weight 0.8 kg with vial and carrying bag

**STRENGTHENED MIDDLE PART FOR
TABLET BRACKETS**



206-CP20SL and 206-CP20SL-L

Carbon fiber pole for GNSS receiver with three fixed heights

- High quality telescope carbon poles
- With safe snap lock, fixed heights at 1.60, 1.80 and 2 m
- Additional central clamp for pole centering via screw nut and conical insert
- With 5/8" adapter (206-CP20SL) or Leica style connector (206-CP20SL-L) for standard GPS height
- Weight 0.95 kg with carrying bag



PN | Carbon Fiber Poles

206-CP22SL and 206-CP22SL-L

Carbon fiber pole for GNSS receiver with three fixed heights

- Telescope pole made of carbon-fiber
- Extended length 2.2 m
- Both poles made of carbon-fiber
- Fixed heights at 1.8, 2.0 and 2.2 m (snap lock)
- Additional central clamp for pole centering via screw nut and conical insert
- With 5/8" adapter (206-CP22SL) or Leica system (206-CP22SL-L) for standard GPS height
- Weight 0.82 kg with carrying bag



206-CAP25TL-5/8 and 206-CAP25TL-L

Carbon-/Aluminum pole for GNSS receivers with three fixed heights

- Extended length 2.50 m
- Outer pole made of carbon-fiber
- Inner pole made of aluminum
- Metric scale
- Locking pin for fixed heights at 1.60, 1.80 and 2.0 m
- Ideal for usage with GNSS receivers
- Twist lock prevents material from damage
- With 5/8" adapter (206-CAP25TL) or Leica style connector (206-CAP25TL-L) for standard GPS height
- Weight 1.2 kg with carrying bag



206-CEP50-5/8 and 206-CEP100-5/8

Carbon pole extension

- Same high quality as our carbon poles
- Extension of 50 or 100 cm available
- Extend your GNSS pole to reduce shadowing and multi path effects
- With high quality 5/8" thread made of stainless steel on both sides
- Very firm screw connection to the pole, no instable movement of the GNSS receiver



PN | Aluminum Poles

206-AP20

Aluminum pole for GNSS receiver with fixed height

- Two-section, yellow pole made of lightweight aluminum
- Fixed height at two meters
- Easy soft-grip
- With 5/8" adapter for standard GPS height
- Weight 1.8 kg with vial and carrying bag



206-AP20

206-AP22SL

Aluminum pole for GNSS receiver with three fixed heights

- Two-section pole
- 3 heights: 1.6, 1.8 or 2 m and collapses to 1.34 m
- Snap-loc for no slip with compression lock
- With 5/8" adapter for standard GPS height
- Weight 1 kg with vial and carrying bag



206-AP22SL

218-4001-FL

Mini prism pole 390 mm

- With 5/8" thread for mounting the prism
- Frequent usage with mini prisms
- Usage as pole extension possible
- With prism pole tip and 20' circular vial
- Weight 680 g



218-4001-FL

218-4047

Mini prism pole 120 mm

- Considerable reduction of errors due to small measuring height
- With 5/8" thread and adjustable 20' circular vial
- Made of aluminum
- Can be used with any prism system having a female 5/8" thread
- Height 120 mm, weight 180 g
- Removable tip



218-4047

218-EPH-BLK and 218-EPH

GNSS Base Pole with Height reading

- For easy and precise height measurement
- 200 mm length, also usable for receivers with UHF antenna
- Male and female 5/8" adapter
- Height lever pulls down and stops at the 90° on horizontal position
- The base pole 218-EPH is made of high quality aluminum. The 218-EPH-BLK consists of light and very robust carbon.



218-EPH-BLK

218-EPH

218-PNMP

Center Punch Point with vial for marking and staking out

- By pressing our marking and stake out tip, it marks the ground point
- Usage with marking bolts which are put into the asphalt
- Marks all metal and non-metal surfaces
- Very precise stake-out and permanent marking
- Can be combined with all types of prisms, 5/8" and Leica style



218-PNMP



218-PNTS

Topo shoe

- Ideal for soft and wet surfaces
- A traditional pole tip would sink into the ground and cause wrong elevation readings. Remove the tip and mount this topo shoe!
- 8.5 cm long, 64 mm outer diameter
- With steel body inside
- Weight 0.6 kg
- For all 5/8" poles



218-PNTS

218-QRA-1

Adapter Leica style connector to 5/8" thread

- Leica style connector on the bottom, 5/8" thread on the top
- Can be combined with the 218-QRA-2 to have a quick release adapter
- Adds 76 mm to the GNSS or prism pole. Please consider this in your software or when postprocessing your data in the office.



218-QRA-1

218-QRA-2

Adapter 5/8" thread to Leica style connector

- Female 5/8" thread on the bottom, Leica style connector on the top
- Can be used as quick release adapter
- Adds 24 mm to your GNSS or prism pole length. Please consider this in your software or when postprocessing your data in the office.



218-QRA-2

218-MF1 and 218-MF3

Magnetic bracket for GNSS antennas

- Magnetic bracket for GNSS antennas on the roof of vehicles
- Very strong magnets to ensure a stable position of the antenna
- With 5/8" thread or Leica style connector for fixing the GNSS antenna
- Available with one or three magnets
- Diameter 95 mm (one magnet) or 115 mm (three magnets)



218-MF1



218-MF3

SKU number	Details
218-MF1	Magnetic bracket with one magnet (5/8")
218-MF1-L	Magnetic bracket with one magnet (Leica style)
218-MF3	Magnetic bracket with three magnets (5/8")
218-MF3-L	Magnetic bracket with three magnets (Leica style)

PN | Prism Poles

Prism poles with easy-to-use quick lock

- Height adjustable 5/8" adapter or Leica system for tilt axis height adaption to all popular prisms
- Metric scale and high quality vial
- Extra hardened steel tip on the pole foot
- The quick lock prevents damage to the material
- Alternating red and white color
- With carrying bag and soft rubber grip (especially comfortable during winter time)

206-SP25QL-5/8 or 206-SP25QL-L

- Length 1.40 m to 2.50 m Weight 1.23 kg

206-SP36QL-5/8 or 206-SP36QL-L

- Length 1.50 m to 3.60 m Weight 1.97 kg

206-SP50QL-5/8 or 206-SP50QL-L

- Length 1.50 m to 4.60 m Weight 2.9 kg

Prism poles with twist lock

- Height adjustable 5/8" adapter or Leica system for tilt axis height adaptation for all popular prisms
- Metric scale
- High quality vial
- Extra hardened steel tip on the pole foot
- The twist lock prevents damage from the material
- Alternating red and white color, 206-SP22TL in flo yellow
- With carrying bag and soft rubber grip (especially comfortable during winter time)

206-SP22TL-Y-5/8 or 206-SP22TL-Y-L

- Length 1.18 m to 2.20 m Weight 1.2 kg
- Without rubber grip

206-SP25TL-5/8 or 206-SP25TL-L

- Length 1.40 m to 2.50 m Weight 1.23 kg

206-SP36TL-5/8 or 206-SP36TL-L

- Length 1.50 m to 3.60 m Weight 1.97 kg

206-SP50TL-5/8 or 206-SP50TL-L

- Length 1.50 m to 4.60 m Weight 2.9 kg

Accessories for prism and GNSS poles

Art.Nr.	Details
218-2090-14	Height adjustable 5/8" adapter
218-2090-10	Stainless steel Leica adapter
218-CPFOOT-SET	Tip for all prism and GNSS poles with 5/8" thread
218-CPTIP	Small steel tip on the bottom of prism pole tips

Adapters below



Quick lock



Twist lock

Soft rubber grip



PN | Bipods & Tripods

206-4160

Mini Prism Bipod

- Solid 30 cm aluminum legs
- Includes a universal head for pole diameters of 25-30 mm
- Includes a heavy duty bag with carrying strap



206-4360 and 206-4361

Range/Prism Pole Bipod

- Side entry head with clamp for easy and quick pole setup
- Rugged locking system provides non-slip quick clamping
- Thumb release style allows easy adjustments
- Fits 25-38 mm diameter poles
- Size 108-182 cm
- Weight 2.13 kg (Aluminum) or 1.95 kg (Carbon)



206-1460

Bipod Leg Clip

- Attaches to the base of any 38 mm diameter prism or GNSS pole
- Bipod legs snap into the clips making the system convenient for storage and transport



206-4250 and 4250SV

Tripod with thumb release

- Tripod creates free-standing setup for GNSS antenna poles
- Top mount universal head will accommodate 25-38 mm diameter poles
- Features large, thumb release buttons for quick setup on even or uneven ground
- Impact resistant materials, replaceable shoes, and quick release telescoping aluminum legs
- Height 206-4250: 108-180 cm
- Height 206-4250SV: 79-116 cm
- Legs extend independently
- Includes carrying bag



218-PNCFT

Field Table

This computer field table (SKU no. 218-PNCFT) is ideal for your laptop when a direct connection between the measuring instrument and a PC is necessary in the field.

This table is made of high quality aluminum and is fixed with a safe clamp on a tripod. The clamp gives the table a well-balanced stability. The table can be extended to the right side in order to have enough space for your PC mouse or your documents. For transport the table can be collapsed and even fits into your laptop bag!

If you adjust the legs of the tripod, you can even work while sitting. Our field table is made in Germany.



PN | Adapters, Tribrachs, Nails

206-6125-20

Fixed tribrach adapter, Wild/Leica type

- 5/8" outer thread
- Made of metal
- Suitable for all tribrachs



206-6125-21

Rotatable tribrach adapter, Wild/Leica type

- 5/8" outer thread
- Made of metal
- Suitable for all tribrachs



206-6125-25

Rotatable tribrach adapter, Wild/Leica type

- With removable DIN tip (Zeiss type) with 5/8" thread
- Made of metal, brass insert
- Suitable for all tribrachs



208-6135-00 and 208-6125-01

Tribrach

- Strengthened version
- High precision tribrachs, ideal for robotic stations
- Type „Wild“ with support cavity to the base plate
- 5/8" thread
- With circular vial
- With (208-6135-00) or without (208-6125-01) optical plummet



208-6145-LL

Tribrach with laser plummet

- Type „Wild“ with with support cavity to the base plate
- With circular vial
- Excellent price-performance relation and high quality
- Ideal for usage with construction total stations
- 205-6146-35BLK-LL with easy-to-use laser plummet



PK Survey Nails

Galvanized, hardened, stainless, flat head with centering, magnetized. Can be easily located with our magnetic locators. Packaging: 100 pieces in a plastic box

SKU number	Details
201-20-751	PK Nails, 100/box, 19 x 3.2 mm
201-20-752	PK Nails, 100/box, 25 x 4 mm
201-20-753	PK Nails, 100/box, 32 x 6.35 mm
201-20-754	PK Nails, 100/box, 38 x 6.35 mm
201-20-755	PK Nails, 100/box, 60 x 6.35 mm
201-20-756	PK Nails, 100/box, 64 x 6.35 mm



PN | Order Form

proNIVO Messgeräte Handels GmbH

Wasserburger Strasse 7

Tel: +49 (0) 8085 - 930 530

Fax: +49 (0) 8085 - 930 550

84427 Sankt Wolfgang, Germany

Internet: www.pronivo.de

Email: info@pronivo.de

Company

Customer no. (if available)

Contact person

Address

Telephone number

Fax number

Email

Delivery address (if different):

Company

Customer no. (if available)

Contact person

Address

Telephone number

Fax number

Email

Order

SKU number	Qty	Description	Price	Total amount

Delivery:

Please send the products

immediately

in week _____/_____

on the date _____/_____/_____

Please indicate your VAT ID number:

Payment:

within 10 days 2% discount, 30 days net

Venue

Date

(Signature)

PN | For Our Customers

How to find us

Sankt Wolfgang is about 30 minutes from Munich, directly on the federal highway B15, approx. 5 km north of Haag. If you are passing by or would like to pick up your order personally - we are looking forward to your visit.

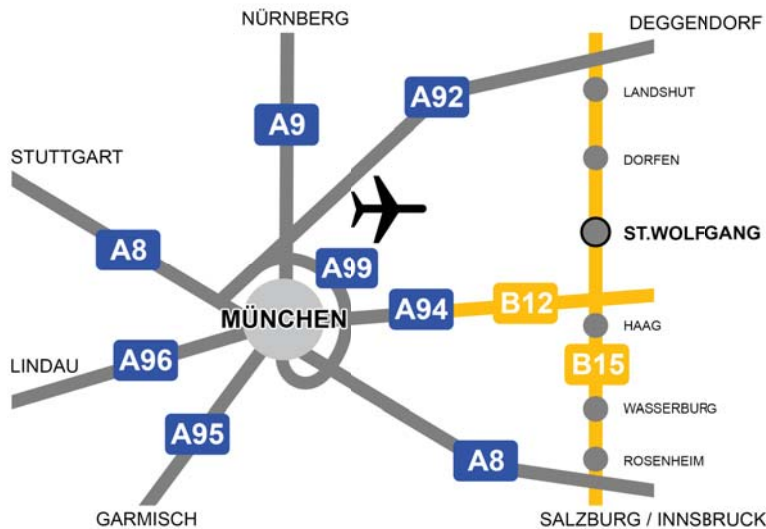

Where to find us

proNIVO Messgeräte Handels GmbH
Wasserburger Straße 7
84427 Sankt Wolfgang
Germany
Telephone: +49 (0)8085 - 930 530
Fax: +49 (0)8085 - 930 550
Email: info@pronivo.de
Web: www.pronivo.de

When to reach us

Our business operating time is:
Monday - Thursday 8:00 - 17:00
Friday 8:00 - 13:00

Delivery time

If you order before 11:45 a.m. and we can ship with UPS, we will send your products on the same day if it is on stock. Using a forwarder the delivery time is about one week.

Shipment

We send packages with UPS. Products on a pallet are sent with a forwarder of our choice (best price). If you prefer a specific shipment method, please let us know when ordering.

Service, maintenance and repairs

For all products in this catalog we perform service, maintenance and repairs by ourselves and have access to the corresponding spare parts or replacement products. Benefit from our quick repair times for your customers as defect products are shipped back to the manufacturer in only very few special cases.

Our service center is your contact for software questions, installations, calibrations and product adjustments. We can provide quick replacements and a fast service to your customers.

We also offer our winter service for measuring and surveying instruments! Our customers can benefit from the winter time with low activity to get freshly calibrated lasers, optical levels and other measuring devices! So they are well prepared for the new construction season!

Contact us for more information!

General terms and conditions

The currently valid General Terms and Conditions of proNIVO Messgeräte Handels GmbH can be found at www.pronivo.de.



proNIVO Messgeräte Handels GmbH

Wasserburger Straße 7
84427 Sankt Wolfgang
Germany

Tel: +49 (0) 8085 - 930 530
Fax: +49 (0) 8085 - 930 550

E-Mail: info@pronivo.de
Web: www.pronivo.de